



The Seven Days of Creation: Genesis 1:1-2:3

	Heaven (and Angels), Earth Covered with Water and Darkness Two Problems: "The earth was Formless and Empty," Gen. 1:2.				
Fixed Formlessness with 3 Days Of Dividing	Day 1		Day 2		Day 3
	LIGHT	Darkness	Water Vapor		Water 
			SKY		
		Water			
Fixed Emptiness with 3 Days Of Filling	Day 4		Day 5		Day 6
	SUN	MOON & STARS			
			BIRDS &		
		FISH			
	Day 7 - Rested				

**THE FIVE JEWISH COVENANTS
& BIBLE CHRONOLOGY**

**THE MESSAGE OF THE BIBLE:
GOD'S PROVISION OF
PERSONAL & NATIONAL
SALVATION VIA MESSIAH**

2000 BC
ABRAHAM
ABRAHAMIC COV.
1) Land
2) Nation
3) Blessing
(Gen 12)

1500 BC
MOSES
LAW COV. vs. LAND COV.
Blessing or Cursing
1) Land

Strangers
Canaan
Egypt

Torah
5 Books

Judges

1000 BC
DAVID
DAVIDIC COV.
2) Nation

Writings
5 Poetry
12 History

Kings
Israel
Judah

Prophets
5 Major
12 Minor

500 BC
JEREMIAH
NEW COV.
3) Blessing

Priests
Babylon
Persia
Greece
Rome

0 AD
70 AD
DESTRUCTION

Gentiles
2000 Years

Jews
2000 Years

Gentiles
2000 Years?

Messiah



border 50 **THE MESSIANIC TEMPLE OF EZEKIEL 40-49**

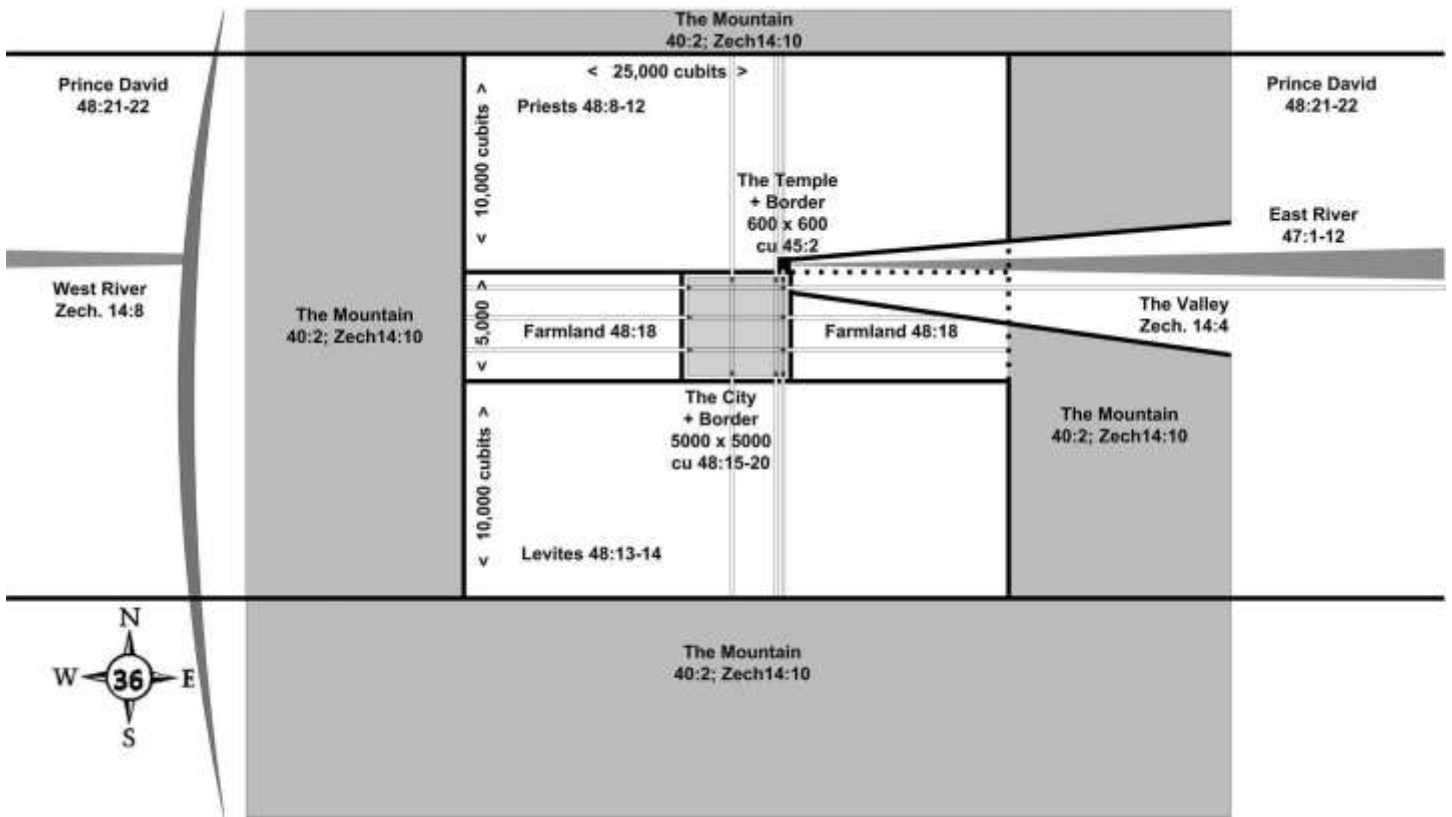
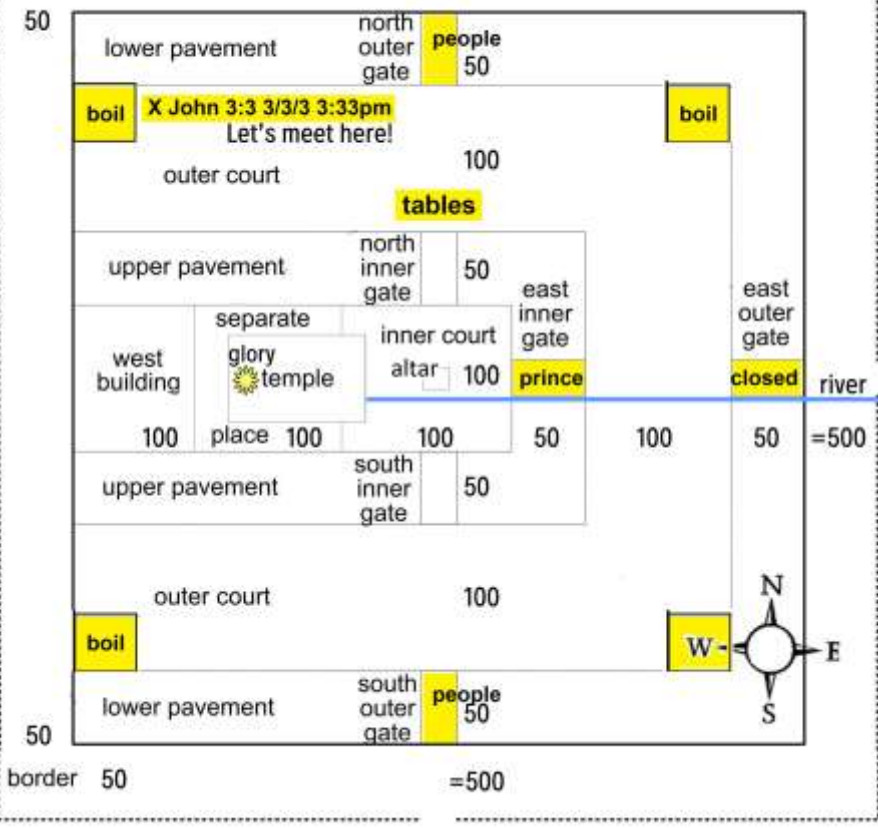

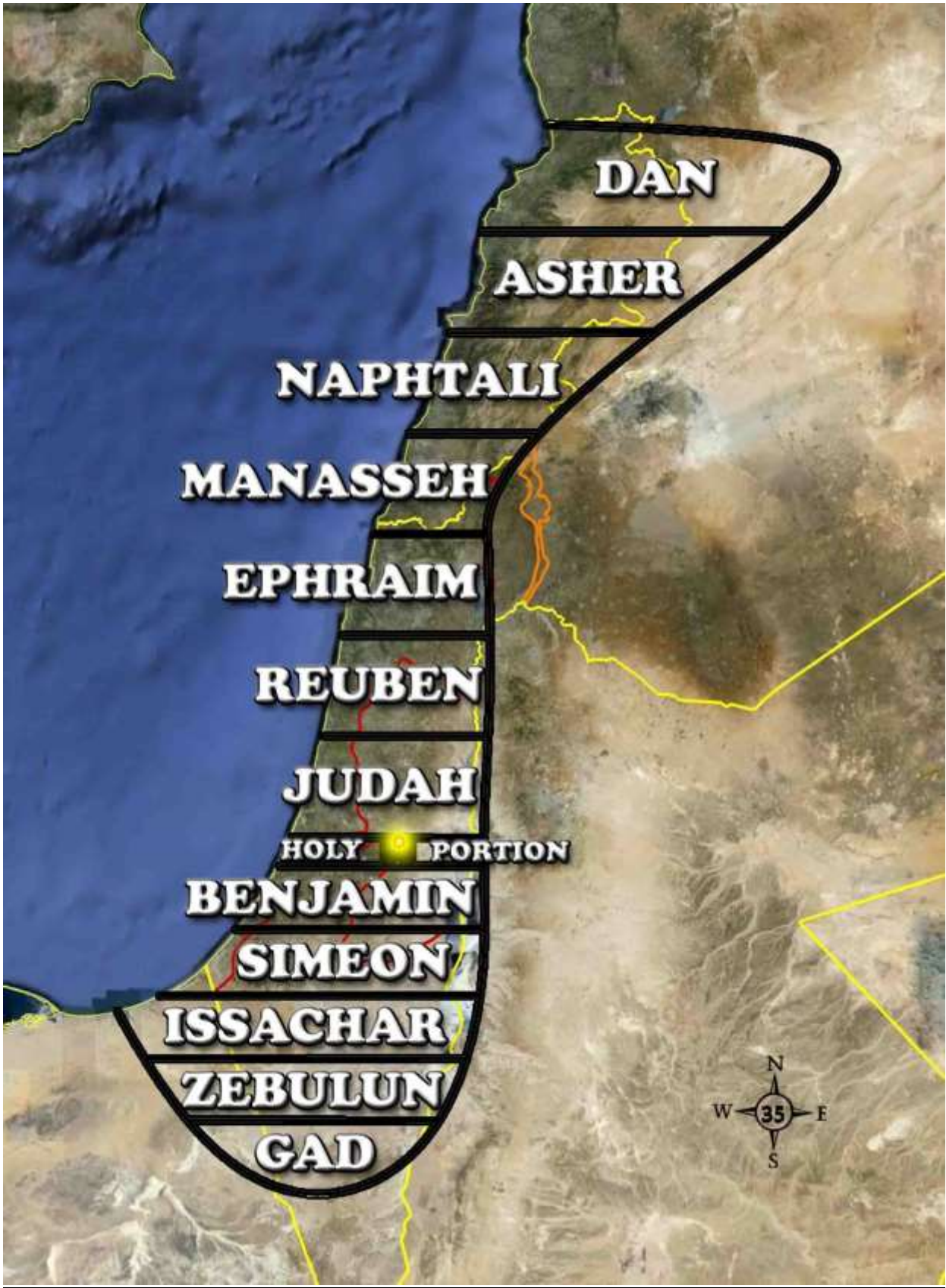

DAN

ASHER

NAPHTALI

MANASSEH

EPHRAIM

REUBEN

JUDAH

HOLY PORTION

BENJAMIN

SIMEON

ISSACHAR

ZEBULUN

GAD



DANIEL 1 - Miracle of Daniel, Shadrach, Meshach, and Abednego and the Kings Food		DANIEL 4 - Miracle of Nebuchadnezzar being like a Beast. DANIEL 5 - Miracle of a Man's Hand and the Fall of Babylon DANIEL 6 - Miracle of Daniel in the Lion's Den			DANIEL 10 - The Gloriously Shining Man	
DANIEL 2 - THE IMAGE OF FOUR METALS		DANIEL 7 - THE FOUR BEASTS		DANIEL 8 - THE RAM AND THE HE GOAT	DANIEL 9 - THE SEVENTY WEEKS	DANIEL 11-12 - THE KINGS
GOLD		BABYLON Nebuchadnezzar Belshazzar	LION		THE COMMAND TO REBUILD JERUSALEM	
SILVER		MEDIA - PERSIA Cyrus the Great Cambyses Bardiya Darius the Great	TWO-SIDED BEAR	RAM WITH TWO UNEQUAL HORNS	SEVEN WEEKS TO JERUSALEM REBUILT (49 YEARS)	FOUR KINGS (Verse 2)
BRASS		GREECE Alexander t. Great 1) Antigonus 2) Ptolemy 3) Seleucus 4) Lysimachus	LEOPARD	HE GOAT ONE HORN AND FOUR HORNS OUT OF ONE OF THEM A	SIXTY-TWO WEEKS TO MESSIAH (434 YEARS)	MIGHTY KING (Verses 3-13)
IRON		ROME	PIERCE BEAST		MESSIAH KILLED / TEMPLE DESTROYED (GAP OF ? YEARS)	KING OF THE NORTH (Verses 14-35)
IRON AND CLAY		TEN KINGS and SATAN'S CHAMPION	TEN HORNS LITTLE HORN	LITTLE HORN GROWS INTO A GREAT HORN	ONE WEEK COVENANT WITH MANY (7 YEARS)	KING OF THE NORTH (Verses 30-39)
STONE CUT OUT WITHOUT MAN'S HANDS		THE MESSIAH, GOD'S CHAMPION	ONE LIKE THE SON OF MAN	THE PRINCE OF THE HOST	THE CONSUMPTION	THE RESURRECTION
STONE FILLS WHOLE EARTH TO BECOME THE KINGDOM OF THE GOD OF HEAVEN		THE MESSIANIC KINGDOM	HIS KINGDOM	MESSIANIC TEMPLE	FORGIVENESS OF SIN EVERLASTING RIGHTEOUSNESS MESSIANIC TEMPLE	EVERLASTING LIFE
DANIEL 3 - The Golden Image and the Miracle of Shadrach, Meshach, and Abednego in the Fiery Furnace with one like the Son of God.						

SURVEY OF MATTHEW - THE CHANGE IN YESHUA'S MINISTRY			
Key Verse 1:1	"Son of David [King Messiah, Davidic Cov.], Son of Abraham [seed and heir, Abrahamic Cov.]"		
Outline Verses	Mt 4:23; 9:35, "Teaching in their synagogues, and Preaching the gospel of the kingdom, and Healing all"		
1-10 Before	Ch 3-4 Preaching The Gospel of the Kingdom	Ch 5-7 Teaching The Law	Ch 8-10 Healing All
11-12 THE REJECTION	Ch 11 Rejected His Preaching: Didn't Repent	Ch 12a Rejected His Teaching: About the Sabbath	Ch 12b Rejected His Healing: Said Demon Possessed
Summary 12c	"This generation," 12:41	"This generation," 12:42	"This ... generation," 12:43-45
13-28 After	Ch 13a Teaching The 2nd Coming In Parables	Ch 13b-16a Healing Only Some	Ch 16b-28 Preaching The Gospel of Messiah

Gospel of John									
Book of Signs									
Sections	Life		Light		Love	Love		Light	Life
Episodes	Faith	Unbelief	Rejection	Judgment	Love				
Chapters	1-4	5-6	7-8	9-10	11-12	13-14	15-17	18-19	20-21

SURVEY OF ROMANS - SALVATION				
I n t r o d u c t o r y		YESHUA	THE LAW	C l o s e
	CONDEMNATION	1b-2a	2b-3a	
	JUSTIFICATION	3b	4	
	Justification Always Results in Sanctification & Glorification	5a	5b	
	SANCTIFICATION	6	7-8a	
	GLORIFICATION	8b	9-11	
	SERVICE	12-15a	15b	

1 JOHN OUTLINE: SECTION 1: LIGHT 1:1-2:12

Non-Christian	General Test 1:6	Faith Test 1:8	Obedience Test 2:4	Love Test 2:9
Claim: Christian	if we say we have union	if we say we have no sin	he that saith I know him	he that saith he is in the light
Evidence	and walk in darkness	(if we say we have no sin)	and keepeth not his com.	and hateth his brother
Verdict re Claim	we lie	we deceive ourselves	is a liar	is in darkness
Verdict re Christian	do not the truth: Jn8:44	the truth is not in us: 2Jn1:2	truth is not in him: Jn14:17	even unto now: 1Thes5:4
Implications: See Logic Diag. #1. No Darkness Walkers are Christians (Tares), No Chrs are DrknWkrs (No Carnal Chrs), All Chrs are LgtWkrs (Joy!)				

Christian	General Test 1:7	Faith Test 1:9	Obedience Test 2:5	Love Test 2:10
Claim: Christian	(if we say we have union)	if we confess our sins	(he that saith I know him)	(he that saith he is in the light)
Evidence	if we walk in the light	(if we confess our sins)	whoso keepeth his word	that loveth his brother
Verdict re Claim	we have union	faithful .. to forgive our sins	truly ... love of God (> know)	abideth in the light
Verdict re Christian	cleanses ... all sin: Eph1:17	cleanses ... all unright: Rev1:5	we are in him: 1Jn4:15	none occasion of stumbl: Jn8:12
Implications: See Logic Diag. #2. All Light Walkers are Christians, No Non-Chrs are LgtWkrs (No Ghandis), All Non-Chris are DrksWkrs				

Non-Christian	Faith Test 1:10	Obedience Test 2:6	Love Test 2:11
Claim: Christian	if we say we have not sinned	he that saith he abideth in him	(he that saith he is in the light)
Evidence	(if we say we have not sinned)	ought ... walk ... as he walked	he that hateth his brother
Verdict re Claim	we make him a liar		is in darkness
Verdict re Christian	his word is not in us: Jn5:38-40		in darkness ... blinded: 2Cor4:4
Implications: See Logic Diag. #3. All Christians and Only Christians are Light Walkers, All Non-Christians and Only Non-Christians are DrksWkrs			

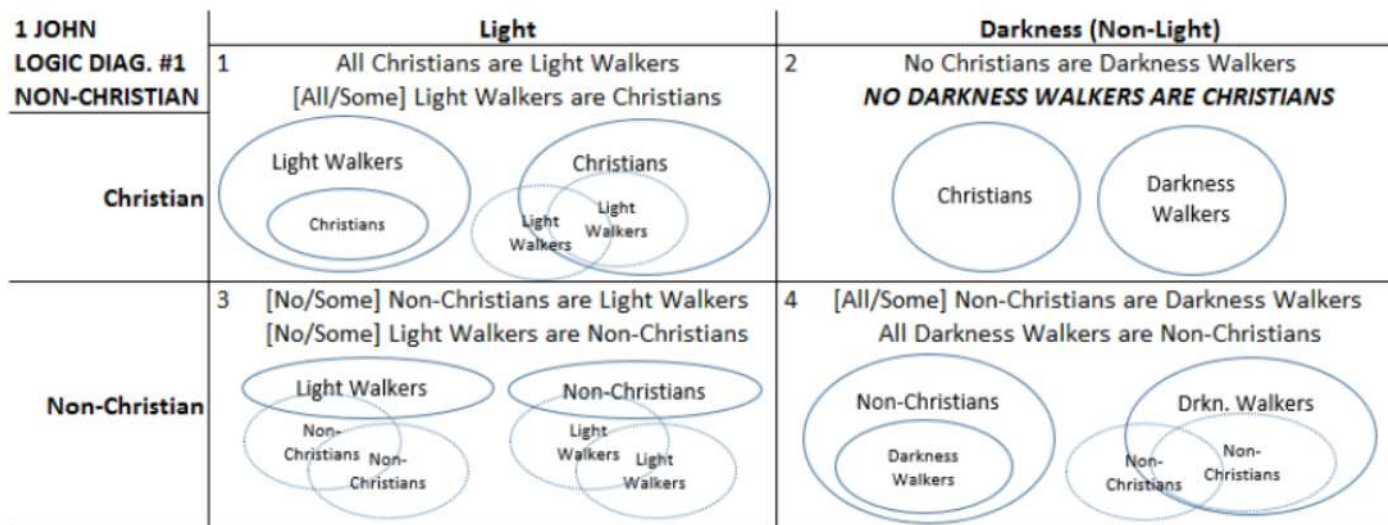

1 JOHN LOGIC DIAG. #2 CHRISTIAN		Light	Darkness (Non-Light)
Christian	1	[All/Some] Christians are Light Walkers ALL LIGHT WALKERS ARE CHRISTIANS	2
Non-Christian	3	No Non-Christians are Light Walkers No Light Walkers are Non-Christians	4

1 JOHN LOGIC DIAG. #3 COMBINED		Light	Darkness (Non-Light)
Christian	1	All Christians are Light Walkers All Light Walkers are Christians	2
Non-Christian	3	No Non-Christians are Light Walkers No Light Walkers are Non-Christians	4

Outline

Introduction 1:1-4

	<i>Intro</i>	<i>Faith</i> <i>(Truth/Doctrine)</i>	<i>Obedience</i> <i>(Righteousness)</i>	<i>Love</i>	
Body	<i>Light</i>	1:5-7	1:8-2:2*	2:3-6	2:7-11**
	<i>Life</i>	2:12-17	2:18-27	2:28-3:10*	3:11-17**
	<i>Knowledge</i>	3:18-24a	3:24b-4:6*	Love	Righteousness
			4:7-5:2*	5:3-17	

Conclusion 5:18-21

The chapter divisions in our Bibles demonstrate a lack of understanding of the structure of 1 John as evidenced by:

**Major sections that end in the middle of a chapter. *Subsections that span two chapters.